

Serie "GT3"
"GT3" series

CM 415



EN 14439 C25



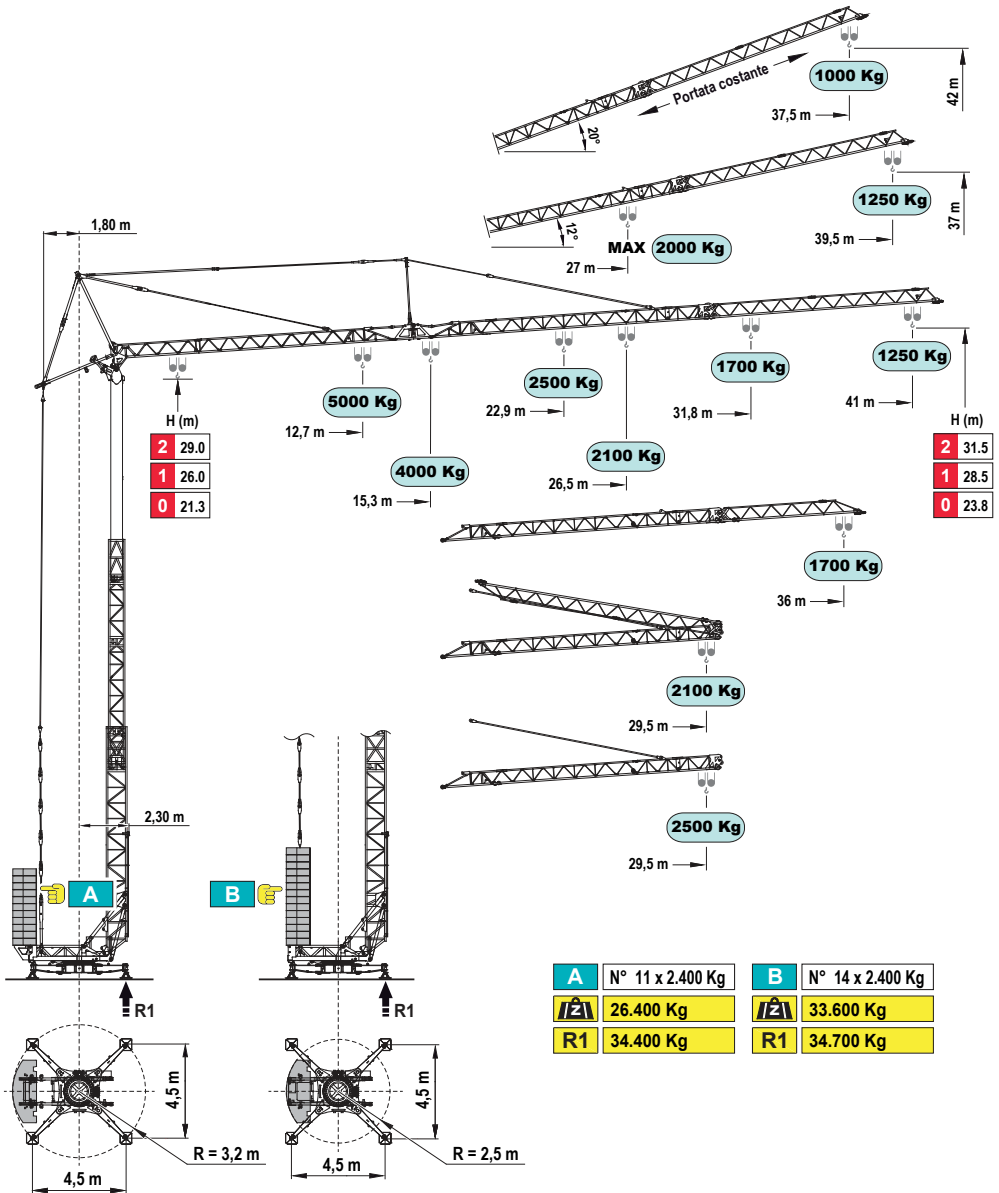

DIN 15018-H1/B3

PROGETTO e COSTRUZIONE / DESIGN and CONSTRUCTION:
LUIGI CATTANEO S.p.A



Curve di carico	kg	5000	4000	3000	2500	2100	1700	1250
Load diagrams	m	12.7	15.3	19.5	22.9	26.5	31.8	41.0
Courbes de charge	m	14.3	17.3	22.0	26.0	30.0	36.0	
Lastkurven	m	14.1	17.0	21.6	25.3	29.5		
Curvas de cargas	m	16.1	19.6	25.0	29.5			

Prestazioni - Performances - Prestations - Leistungen - Prestaciones

		kVA	400V - 50Hz 20 kVA					
 inverter	kW	12,5		1°	2°	3°	4°	
				m/min	3,5	14	27	53
				kg	5.000	5.000	2.500	1.250
 inverter	3,0	Kg 0 → 3.000	m/min	18 - 37 - 50				
		Kg 0 → 5.000	m/min	18 - 37				
 inverter	5,5		g/min	0,2 - 0,5 - 0,9				

Montaggio - Erection - Montage - Montage - Montage

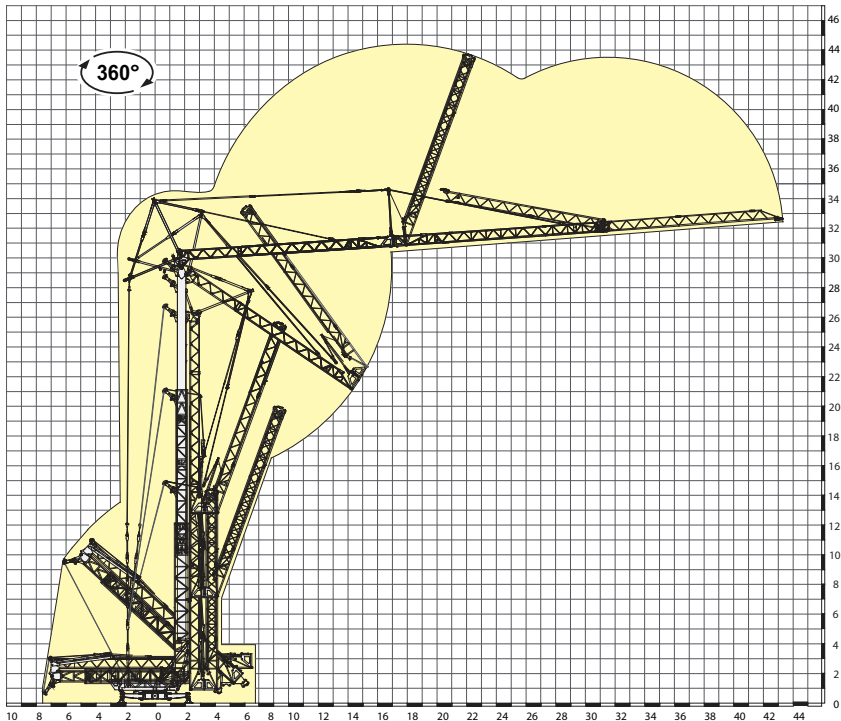

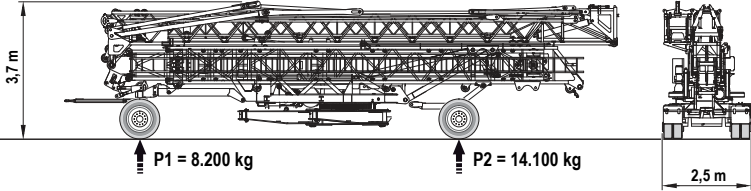
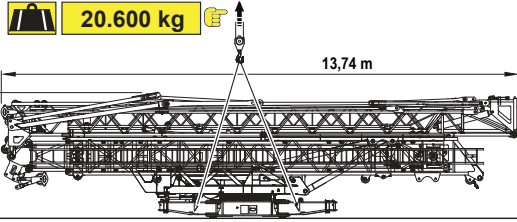

T1S1

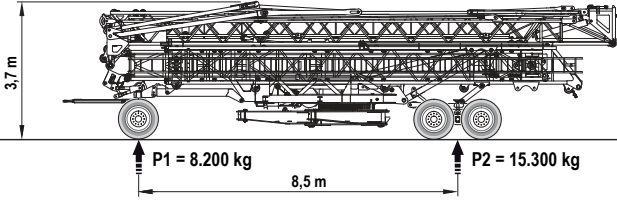

25 Km/h

R120

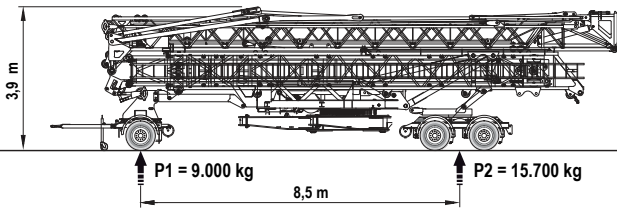

Otto 80 Km/h
Dir. 2007/46/CE

S020

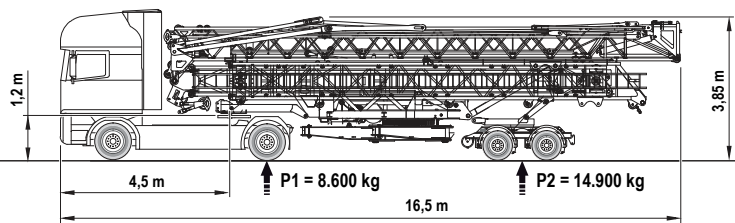

Otto 80 Km/h
Dir. 2007/46/CE

N°2 container 40' open top

