

Serie **“Traino veloce”**  
**“Fast Running”** series

# CM 301

**Gru idraulica a montaggio rapido**  
*Hydraulic crane with quick assembling*  
**Grue hydraulique à montage rapide**  
*Hydraulischer Schnellmontagekran*  
**Grúa hidráulica de montaje rápido**















EN 14439 C25

FEM1.001-A3

PROGETTO e COSTRUZIONE / DESIGN and CONSTRUCTION:  
**LUIGI CATTANEO S.p.A**



## Prestazioni - Performances - Prestations - Leistungen - Prestaciones

				1°R*	1°	2°	3°	4°	kW
		 230V - 3,0 kVA <b>1</b>	m/min.	1	5	8	12	18	7,5
			kg	2.500	2.500	1.500	1.000	600	
		 230V - 4,5 kVA <b>2</b>	m/min.	1	5	13	18	26	
			kg	2.500	2.500	1.500	1.000	600	
	 230V - 6,0 kVA <b>3</b>	m/min.	1	5	12	22	32		
		kg	2.500	2.500	2.500	1.000	600		
	 400V - 12 kVA <b>4</b>	m/min.	1	5	18	30	40		
		kg	2.500	2.500	2.500	1.500	1.000		
		m/min.	1	5	18	30	40		
		kg	2.500	2.500	2.500	1.000	1.000		
	 230V <b>1 2 3</b>	m/min.	5	20	30	40	3,0		
		 400V <b>4</b>	m/min.	5	20	35		50	
		g/min.	0,1	0,2	0,4	0,9	2,2		

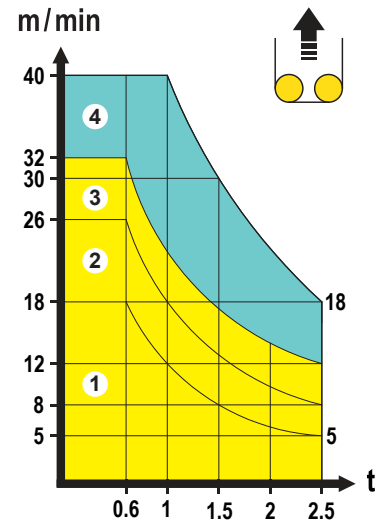

\* Disponibile SOLO con radiocomando a manipolatore predisposto per questa funzione  
Available ONLY with manipulator radio control suitable for this function

## Montaggio - Erection - Montage - Montage - Montaje

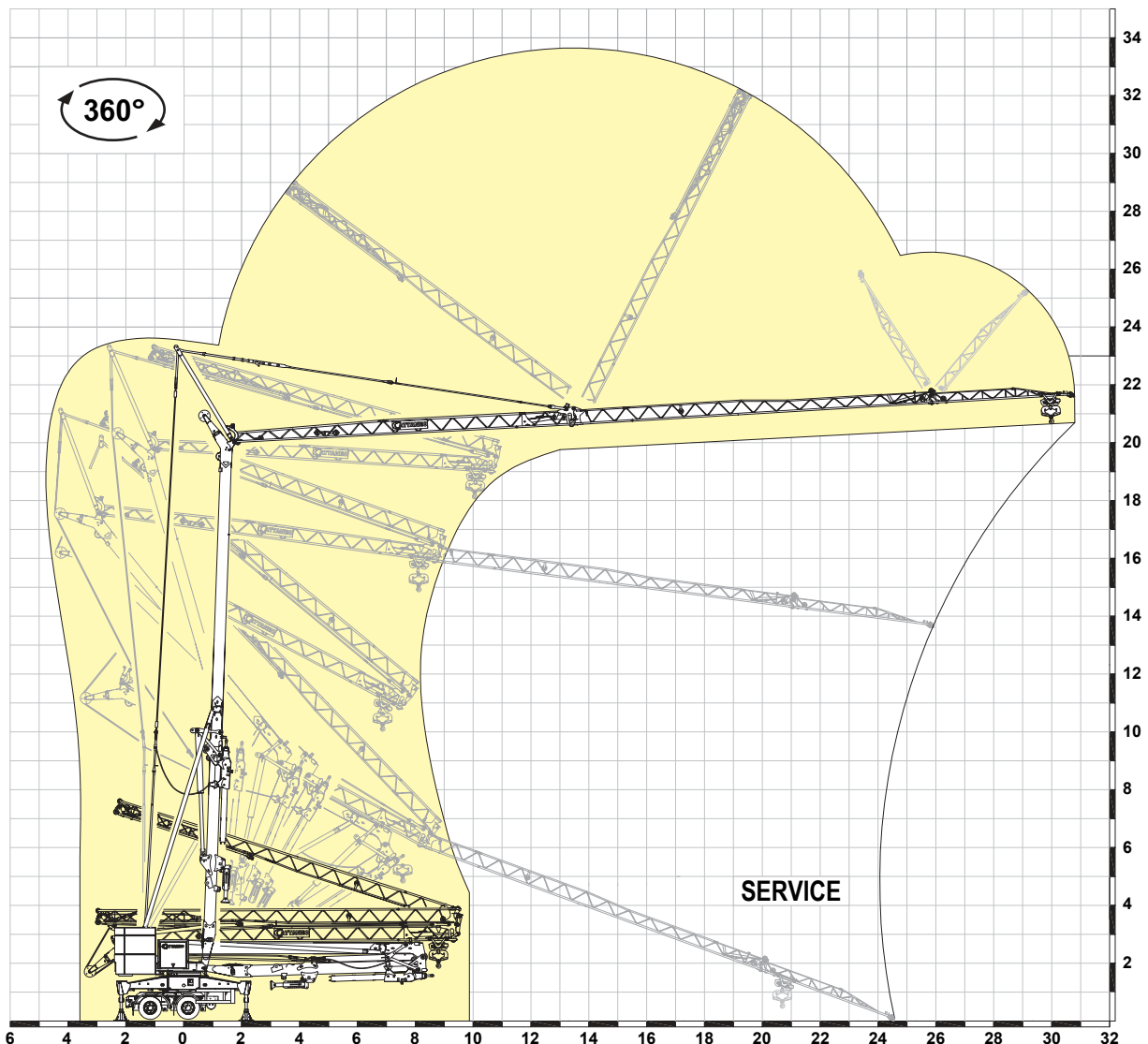

# CM 301

Contrappeso in lastre di cemento armato - Ferro-concrete ballast slabs  
 Contrepoids en plaques de béton armé - Gegengewicht aus Betonplatten - Lastre en hormigón armado

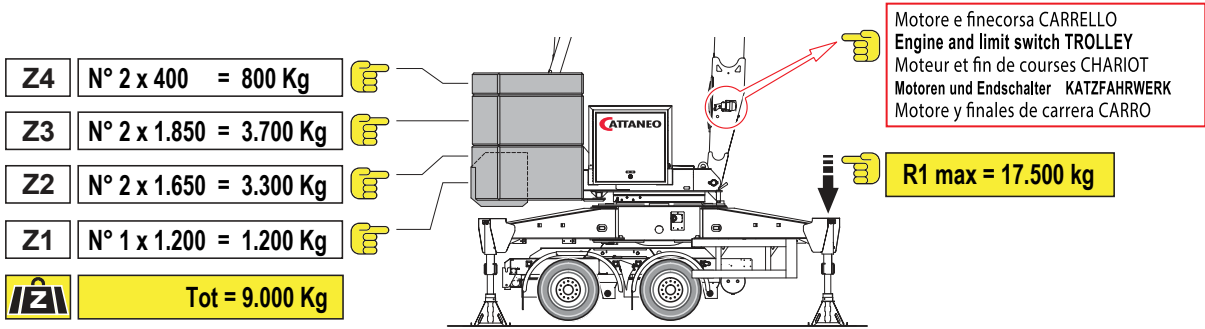

## Trasporto - Transport - Transport - Transport - Transporte

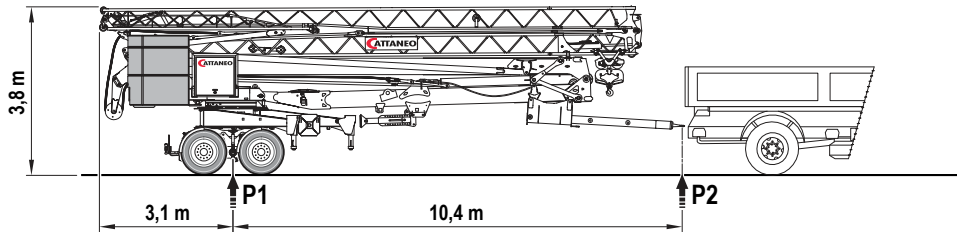
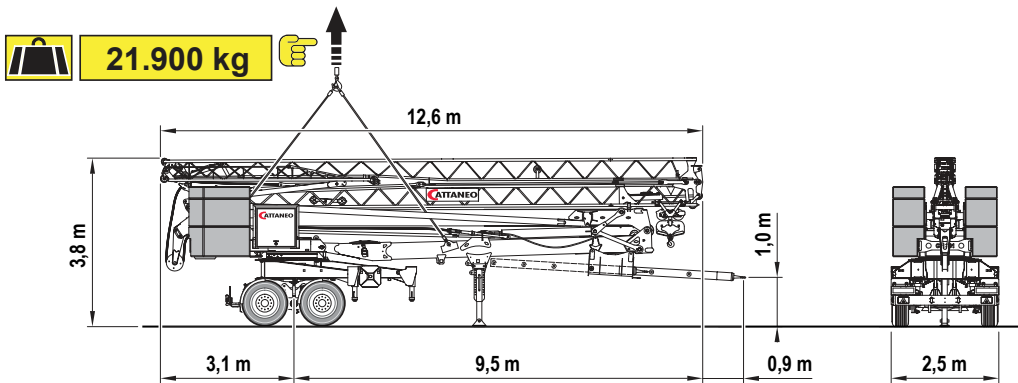

**25 km/h**  
 P1 kg P2 kg  
**21.000 900**  
 ABE (TUV) § 20-22 StVZO

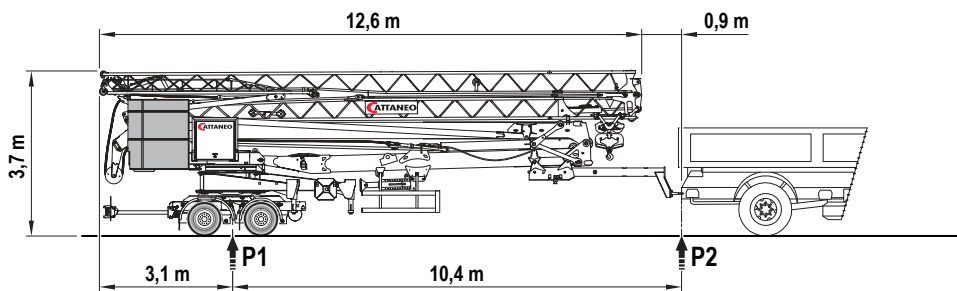

**80 km/h**  
 P1 kg P2 kg  
**21.590 970**  
 ABE (TUV) § 20-22 StVZO

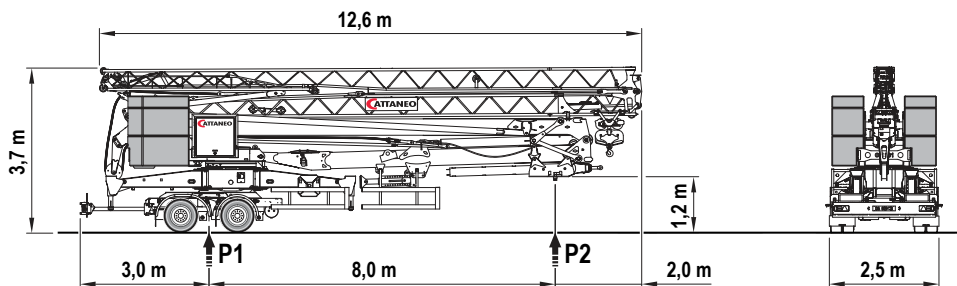

**D4SG02**  
**80 km/h**  
 P1 kg P2 kg  
**19.950 2.650**  
 Dir. 2018/858/CE